

Diritti riservati

All rights reserved

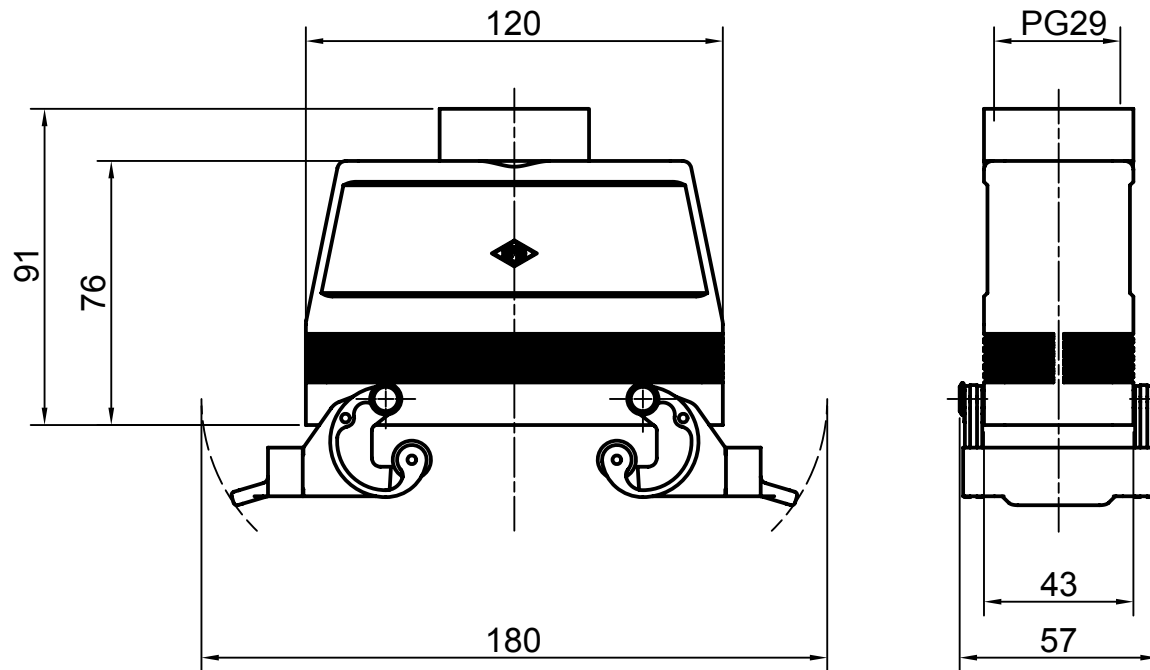

Date 04.01.2007	CMAV 16 X29		Scale
Sign.	hood top entry with 2 lev. PG29 ins.		1:2
			